

Příloha č. 1. – rozmístění 40 ks akademických vzorků na tiskové platformě

Pozice 1 33ks

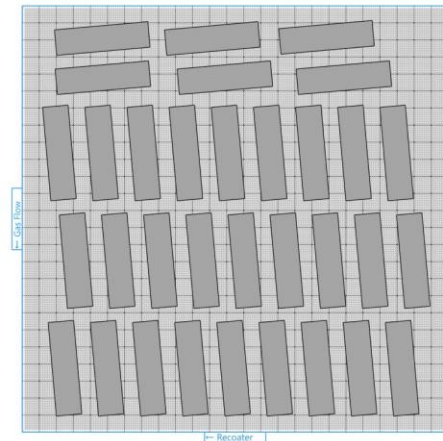

7ks

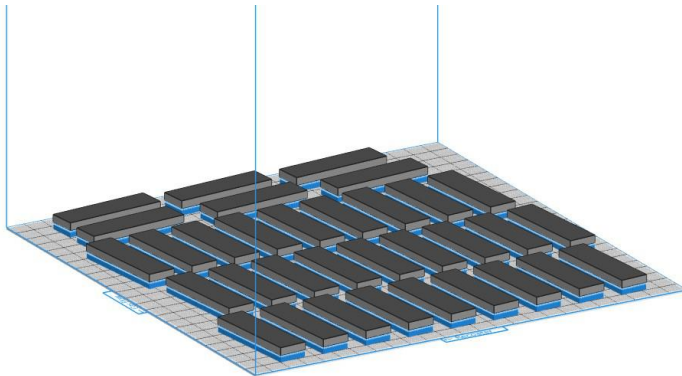
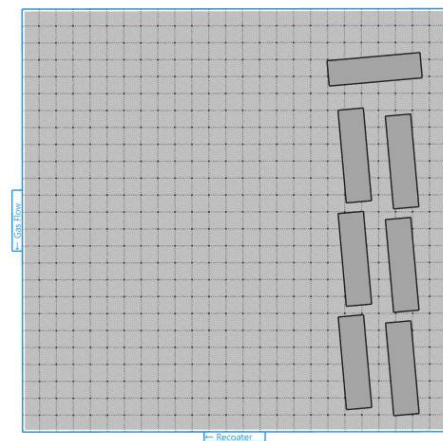
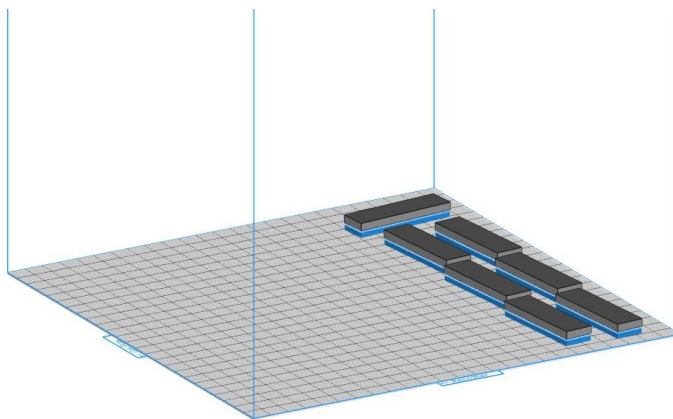

Pozice 2

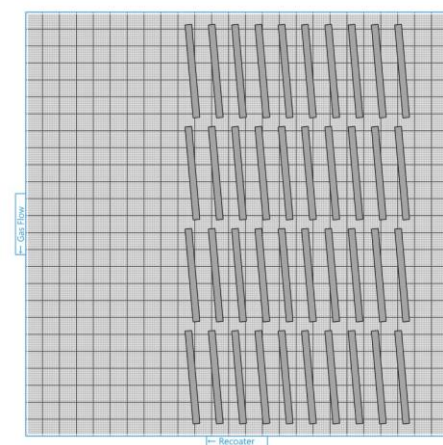
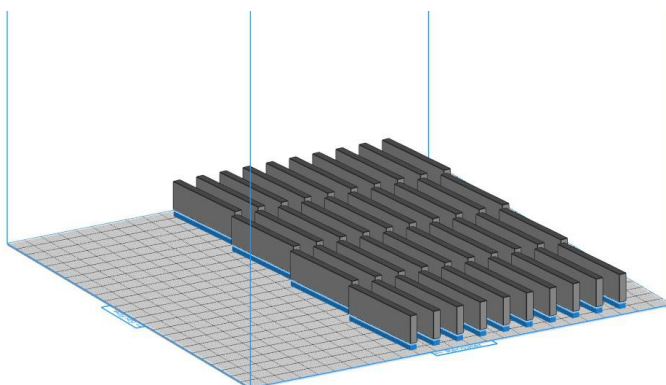

Pozice 3

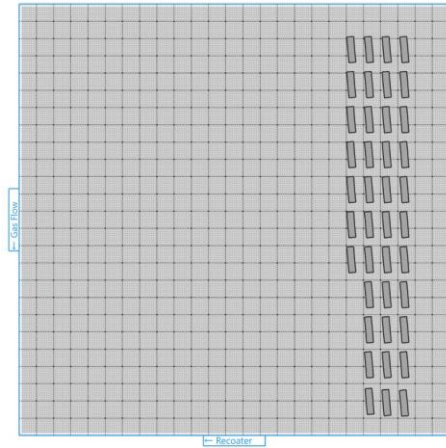
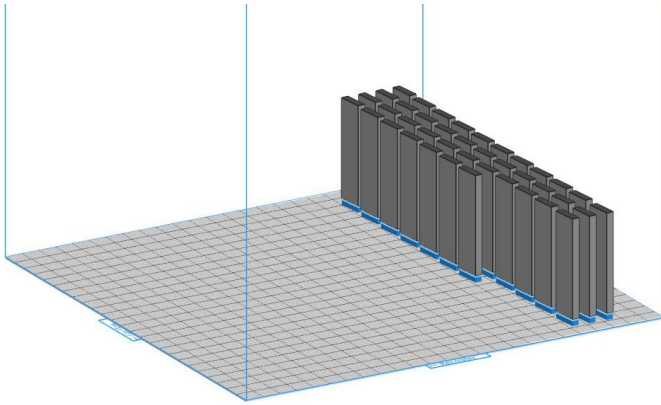

Pozice 4

33 ks

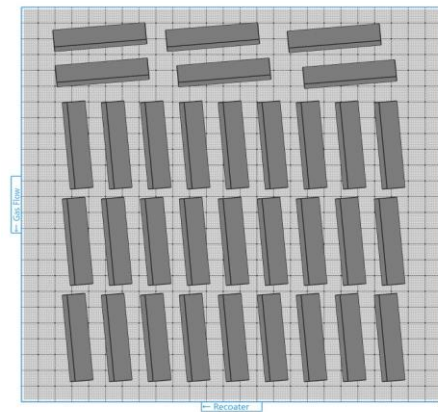
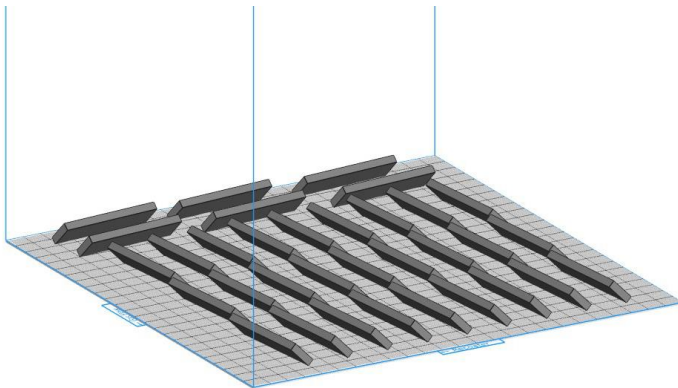

7ks

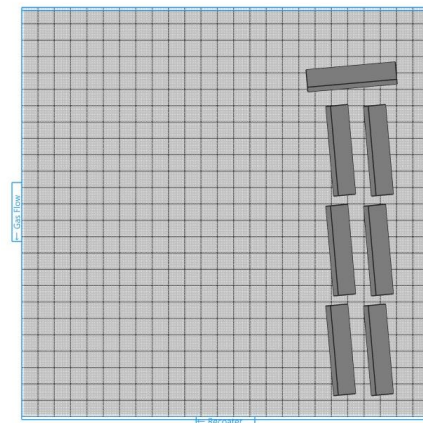
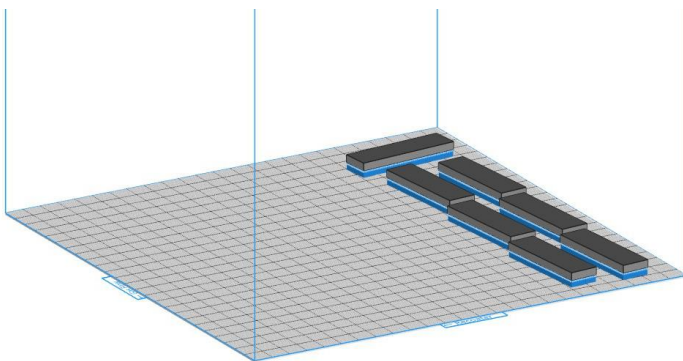

Pozice 5

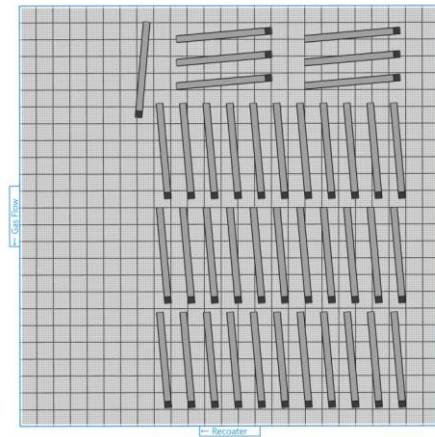
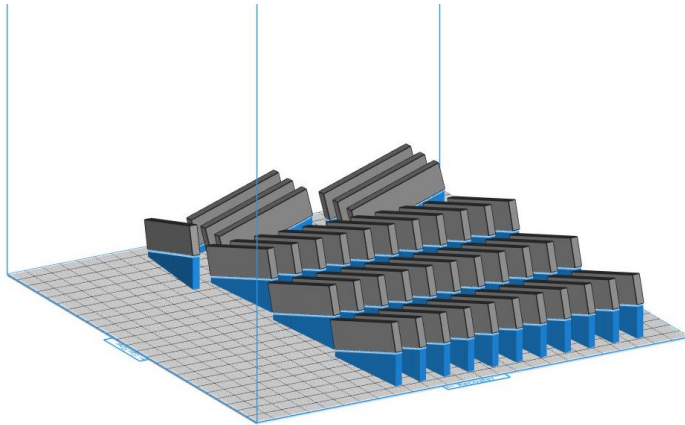

Pozice 6

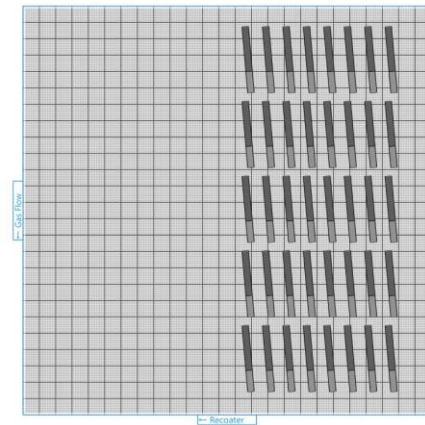
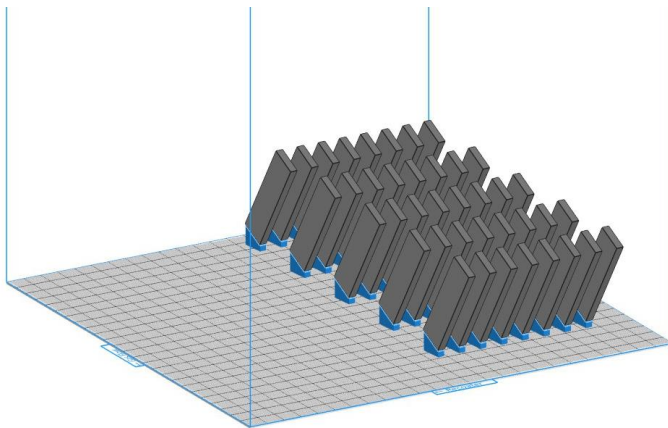

Pozice 7

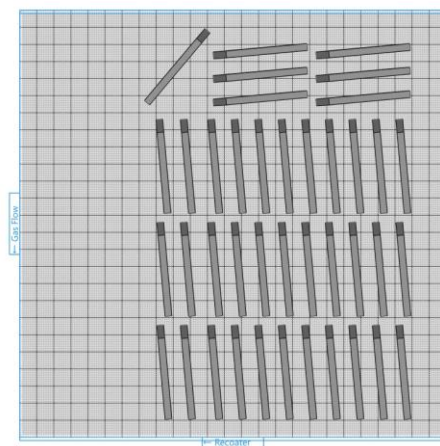
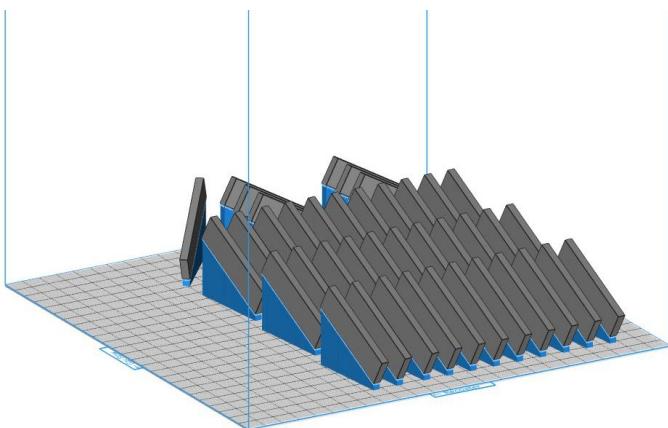

Pozice 8

35 ks

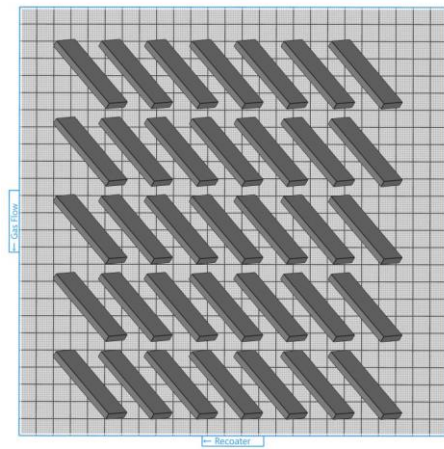
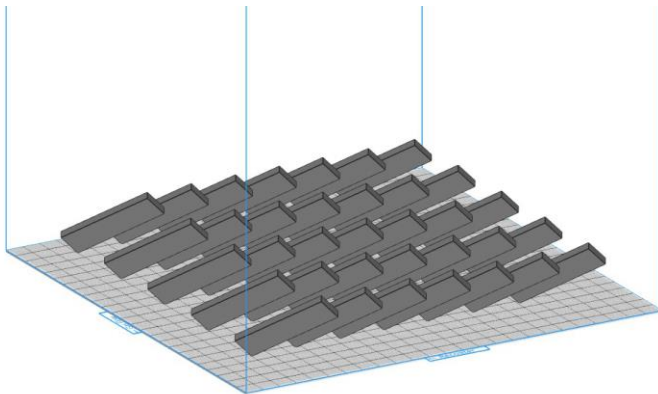

5 ks

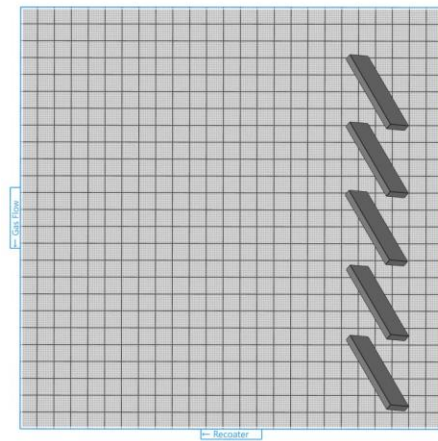
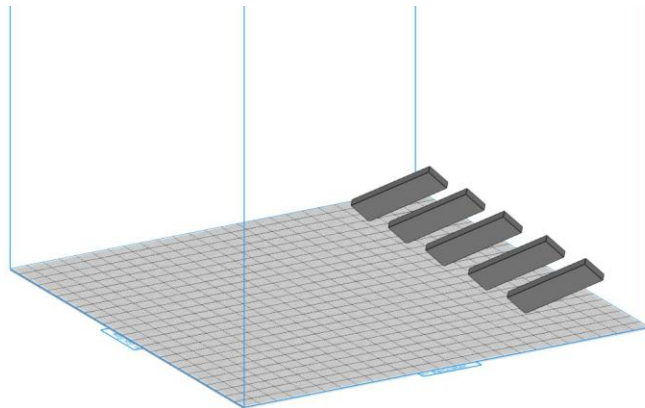

Pozice 9

31 ks

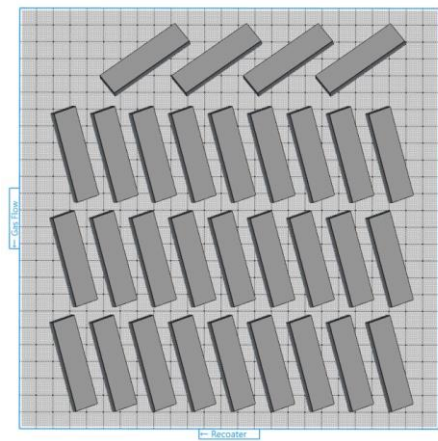
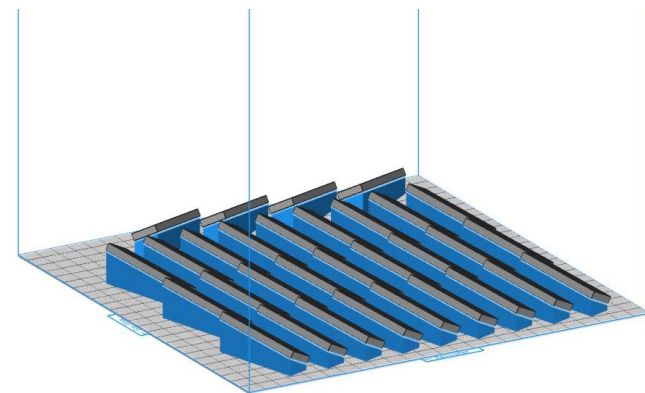

9 ks

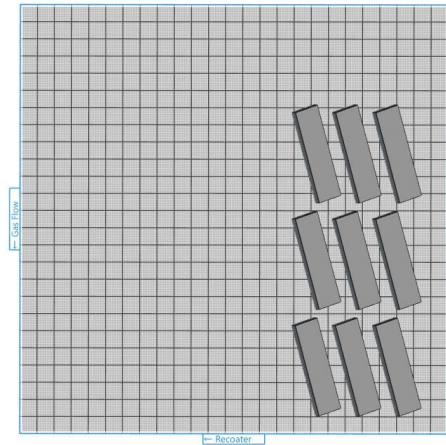
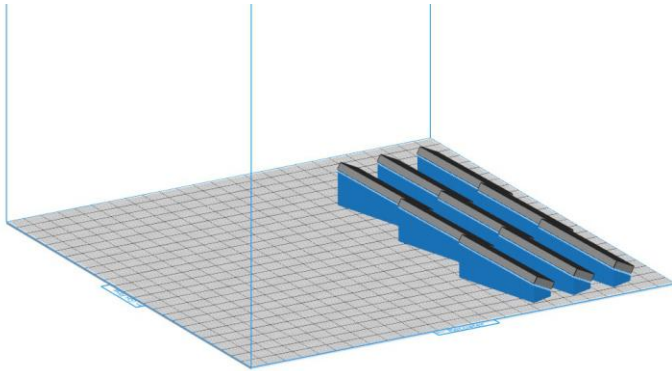

Pozice 10

30 ks

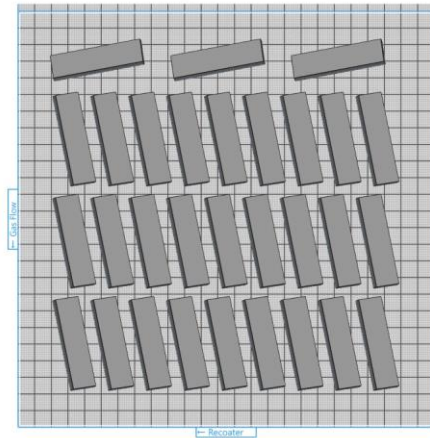
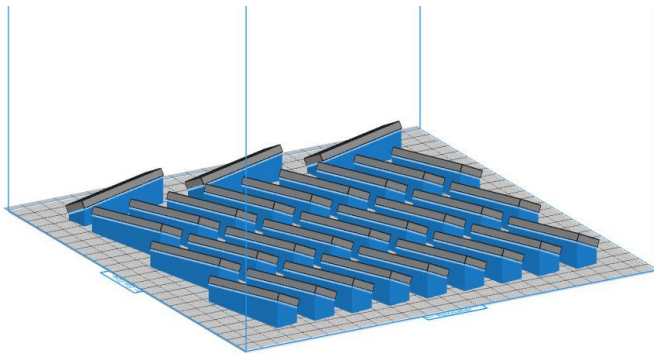

10 ks

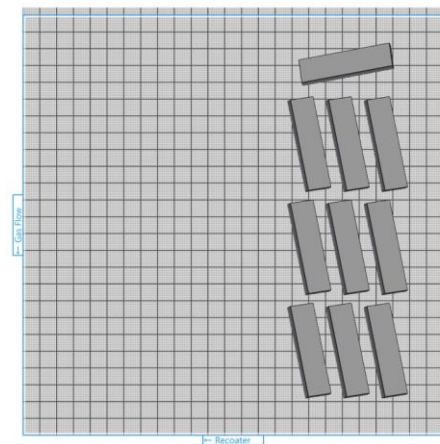
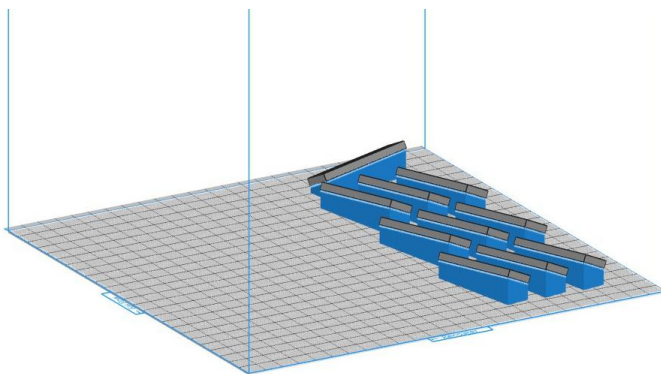

Příloha č. 2. - rozdělení technologií a využívaných materiálů

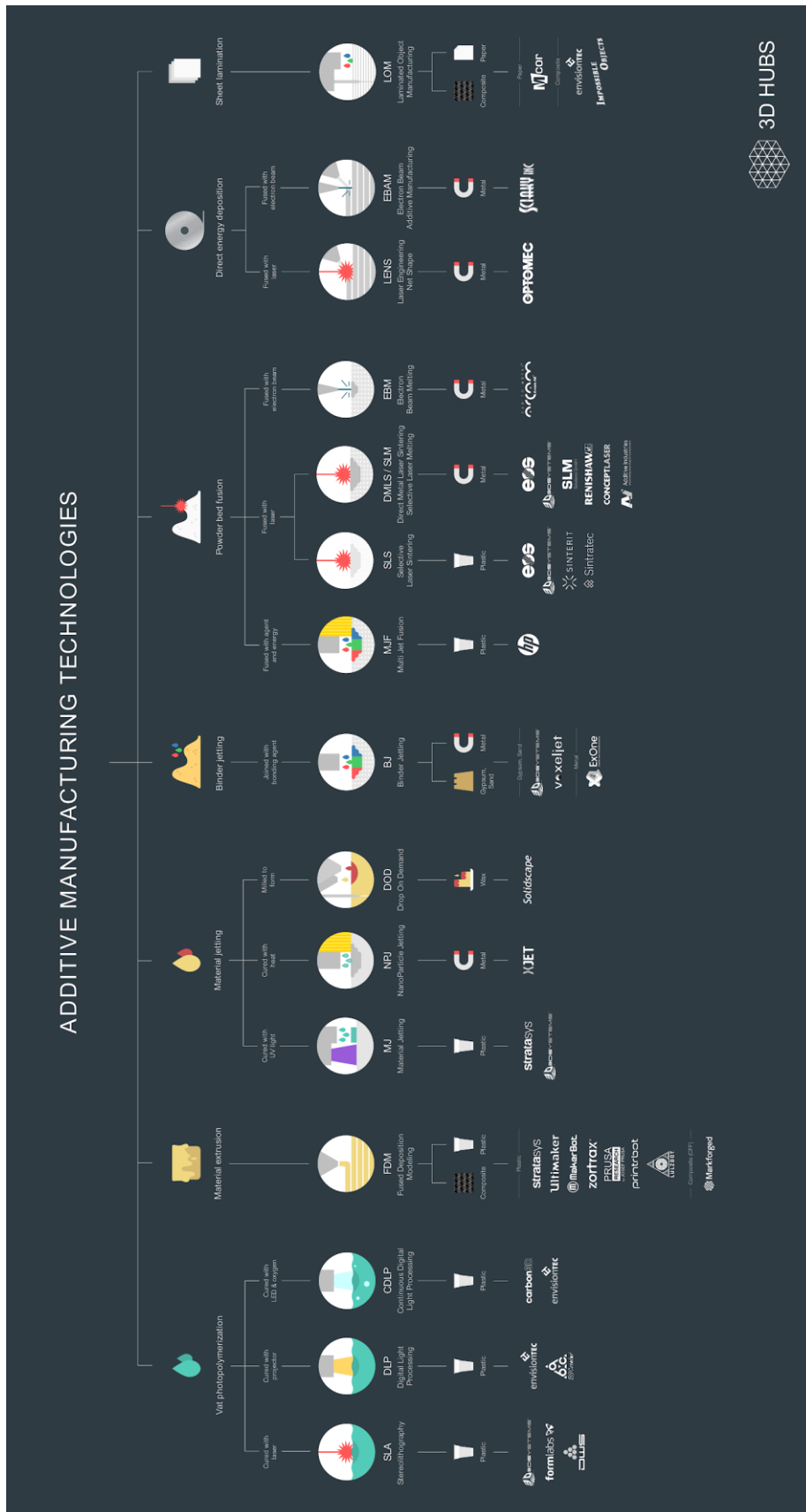

Příloha č. 3. – data z reálných tisků

Vzorek	Objem dílů [mm ³]	Objem podpor [mm ³]	Celkový objem [mm ³]	Vrstev [ks]	Čas tisku - EOSprint [h:m:s]	Čas tisku - EOS tiskárna [h:m:s]	Celkový čas [s]	Celkový čas [s]
1	49966,800	16314,000	66280,800	1253	26:36:28	26:33:02	95788	95582
2	899986,370	3520,040	903506,410	4538	100:02:00	99:47:30	360120	359250
3	770627,840	27369,900	797997,740	4538	100:04:54	99:13:03	360294	357183
4	114940,655	46548,474	66280,800	751	19:47:15	19:45:33	71235	71133
5	41331,000	0,000	41331,000	2976	139:21:00	139:14:04	501660	501244
6	4695,005	2483,716	7178,721	468	1:52:59	1:51:34	6779	6694
7	456669,000	156200,000	612869,000	476	26:13:47	26:12:19	94427	94339
8	195623,625	84451,994	280075,619	725	28:09:54	28:08:08	101394	101288
9	118505,000	0,000	118505,000	1701	25:47:57	25:43:27	92877	92607
10	9113,307	2500,137	11613,444	608	3:57:54	3:56:11	14274	14171
11	125281,000	1821,000	127102,000	1701	41:09:04	40:44:53	148144	146693
12	309951,000	53882,000	363833,000	1038	38:55:42	38:20:35	140142	138035
13	28094,180	12078,629	40172,809	608	20:15:46	20:14:03	72946	72843
14	156778,000	79696,000	236474,000	3851	64:00:00	64:02:16	230400	230536
15	199731,000	79696,000	279427,000	4538	100:02:00	99:48:11	360120	359291
16	34203,876	13862,445	48066,321	613	22:19:00	22:17:40	80340	80260
17	67523,740	56725,995	124249,735	931	12:35:00	12:33:15	45300	45195
18	4246,515	2383,841	6630,356	438	3:30:00	3:28:32	12600	12512
19	202558,000	1764,000	204322,000	3346	28:07:12	27:58:32	101232	100712
20	30600,000	31950,000	62550,000	2367	77:30:00	76:59:28	279000	277168
21	10669,000	0,000	10669,000	3351	16:00:00	15:41:57	57600	56517
22	47117,168	0,000	47117,168	3751	13:40:26	13:29:05	49226	48545
23	22295,210	27369,900	49665,110	627	5:10:00	5:16:19	18600	18979
24	31137,000	7569,000	38706,000	876	8:19:38	8:26:45	29978	30405
25	101028,000	62639,000	163667,000	1436	23:00:00	22:34:11	82800	81251
26	83197,000	14294,000	97491,000	858	14:00:00	13:49:46	50400	49786
27	132818,479	63897,528	196716,007	1602	41:58:00	41:50:00	151080	150600
28	18148,497	17437,527	35586,024	1287	13:09:15	13:05:42	47355	47142
29	16529,000	14125,000	30654,000	1615	7:30:36	7:26:32	27036	26792
30	17748,000	181271,000	199019,000	2570	26:14:15	26:07:24	94455	94044
31	219002,120	197594,636	416596,756	1631	72:32:29	73:39:13	261149	260953
32	26318,439	6220,893	32539,332	513	15:37:00	15:31:23	56220	55883
33	28036,203	10861,537	38897,740	513	17:22:38	15:54:06	62558	57246
34	18079,356	5525,095	23604,451	876	7:31:00	7:18:05	27060	26285
35	31358,000	19313,000	50671,000	1506	10:40:00	10:33:12	38400	37992
36	66589,000	10959,700	77548,700	1506	22:30:00	22:31:50	81000	81110
37	199908,390	4725,838	204634,228	2588	58:30:40	58:23:55	210640	210235
38	124980,000	66007,000	190987,000	2113	25:45:00	25:26:22	92700	91582
39	124980,000	0,000	124980,000	2013	15:15:00	14:58:11	54900	53891
40	21137,000	17001,000	38138,000	2833	51:24:00	51:00:22	185040	183622
41	18033,000	9037,000	27070,000	3176	16:10:00	15:46:16	58200	56776
42	12371,000	4007,000	16378,000	526	20:32:00	20:29:20	73920	73760
43	44657,000	20260,000	64917,000	558	34:00:00	33:46:05	122400	121565
44	11726,000	4950,000	16676,000	391	28:00:00	28:34:41	100800	102881