

Analysis of Multilevel Electronic Balancer for AC Traction Substation with PS-PWM

Vojtech Blahnik, Milos Straka
Regional Innovation Centre for Electrical
Engineering
University of West Bohemia
Pilsen, Czech Republic
lucke@kev.zcu.cz, strakami@rice.zcu.cz

Martin Pittermann
Department of Electromechanics and Power
Electronics
University of West Bohemia
Pilsen, Czech Republic
pitterma@kev.zcu.cz

Abstract – The main goal of this paper is the analysis of an behavior for the electronic balancer of the AC traction substation. This balancer consists of three delta connected multilevel cascade H-bridge converters. The employed phase-shifted pulse width modulation causes the significant decrease of the current ripple due to multilevel nature of the voltage at the converter AC terminals. This paper describes the basic level of modulation technique for single H-bridge cell and analyzes low harmonic interferences of the converter. These results are extended to twelve cells H-bridge multilevel converter with 250 Hz switching frequency. The results of the analysis are based on a created model of the multilevel converter with the nominal power of 12.5 MVA (for traction substation use).

Keywords- multilevel converter; CHB modulation; harmonic analysis; railway substation

I. INTRODUCTION

This paper deals with the fundamental analysis of single-phase multilevel converters and harmonic distribution for mathematical models of converter. Multilevel converters are used in a wide range of high-power applications including renewable energy resources, power transfer grids, high-power electric transport vehicles, etc. In literature, there were published many multilevel topologies are also described including neutral point clamped (NPC/ANPC), flying capacitor (FC), cascaded H-bridge (CHB) converters, and many other modifications [1] and [2]. This paper focuses on CHB converters, which are see e.g. [2] - [6], the most popular solution for grid-connected converters.

CHB converter technology is also very important for single-phase grid. The special application is a railway AC traction system, which is possible to use for a substation or medium-frequency transformer (MFT) locomotives. This paper solves harmonic distribution in CHB converter. This converter is main part of the substation with the electronic balancer. This application is a promising industrial solution, that can be tracked in [3] and [4]. This substation topology provides reactive power compensation and power symmetrization by using electronic balancers (based on delta connection CHB topology). The power circuit of CHB consists of serial connected power cells (H-Bridges). Each cell contains an H-Bridge (HB) converters with a separated DC-link capacitors. The number of cells is important data for the converter

behavior analysis and harmonic distribution. Because, a catenary grid is directly connected to the power grid, total harmonic distortion (THD) and current harmonic distribution is necessary for monitoring, due to inclusion to the smart grids and for industry and transport 4.0.

The basic part of a CHB converter is the HB cell, shown in Figure 1. The HB interference depends on the modulation technique of converter, control algorithm, properties of power semiconductor devices and filter components. The most common modulation technique used for this type of converter is Pulse Width Modulation (PWM) described in [7]. For a CHB topology converter is suitable PWM with zero vector alternating, described in [8]. There is full background and harmonic composition analysis in paper [9]. The selected PWM using control signal and symmetrical saw signal. The asymmetrical sampling with triangular carrier (control signal is sampled at a separate control loop which is independent on saw signal). This solution is used for minimizing control loop transfer delay (50µs is control loop sampling time). The principle of the selected PWM technique is depicted in Figure 1. The behaviors of controls, modulations and firing signals are present in Figure 2. The triangular saw is compared with control signals (sampled on 20 kHz). Harmonic series of saw signal contains odd multiples of saw fundamental frequency (250 Hz, 750 Hz, 1250 Hz, ...), as a described in equation (1). Therefore, the harmonics components of one cell HB is around 500 Hz (double of control signals). The Complete mathematical description of AC terminals of voltage (u_v) for one cell HB can be found in [7], that is source for general equation (2). Where A is magnitude, V_{dc} is DC link voltage, ω_0 is angular speed for fundamental harmonic and ω_c is angular speed for carrier signal.

$$saw(t) = \frac{8A}{\pi^2} \left(\sin(\omega t) - \frac{1}{9} \sin(3\omega t) + \frac{1}{25} \sin(5\omega t) + \dots \right) \quad (1)$$

$$u_v(t) = \frac{4V_{dc}}{\pi} \sum_{n=1}^{\infty} \frac{1}{\left[n \frac{\omega_b}{\omega_c} \right]} J_n \left(n \frac{\omega_b}{\omega_c} \pi M \right) \sin n \frac{\pi}{2} \cos(n\omega_b t) +$$

$$\frac{4V_{dc}}{\pi} \sum_{m=1}^{\infty} \sum_{n=-\infty}^{\infty} \frac{1}{\left[m+n \frac{\omega_b}{\omega_c} \right]} J_n \left(\left[m+n \frac{\omega_b}{\omega_c} \right] \pi M \right) \sin n \frac{\pi}{2} \times \cos(m\omega_c t + n\omega_b t) \quad (2)$$

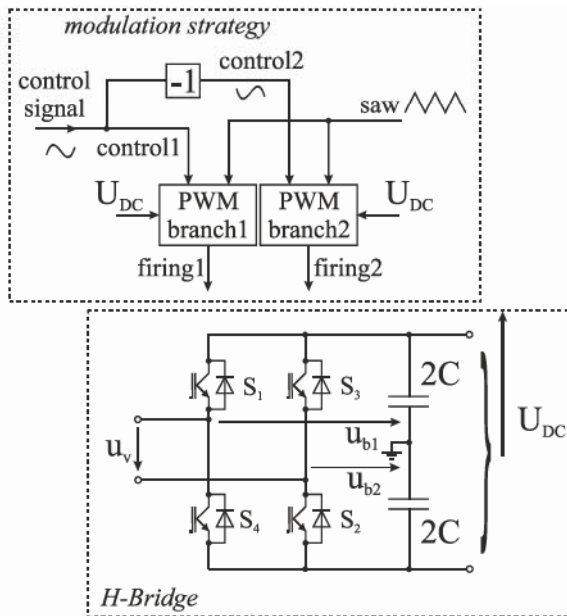

Figure 1. PWM modulation strategy for H-Bridge cell (modulation with zero vector alternating)



Figure 2. Illustration of signals PWM for H-Bridge cell based on modulation with zero vector alternating

This single HB analysis is possible to use for CHB converter shown in Figure 3. Each phase is analyzed (voltage u_{CHB} and current i_{bal}) separately, because each phase is controlled by different control signals.

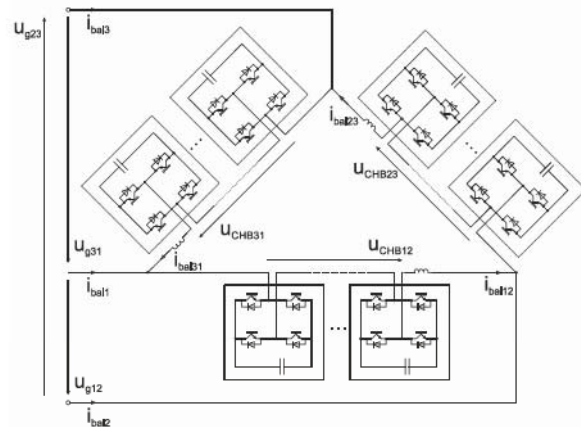

Figure 3. Example of using of CHB multilevel converter as a branch of converter for power symmetrization

II. DETAIL SIGNALS ANALYSIS

The analysis of a CHB converter for power symmetrization is based on simulation model Figure 3. where the parameters are listed in Table I. The behavior of AC voltage of one cell HB is shown in Figure 4. There you can see a positive half period (10 ms). The switching frequency 500 Hz is possible to see (resulting from doubling of 250 Hz of saw signal). This fact is documented in Figure 5. where the results of harmonic analysis are shown. The side band corresponds to the assumption from [7] and [9].

The details of modulation signals under PS-PWM (for positive half period 10 ms) are shown in Figure 6. This modulation technique creates multilevel waveform on AC terminal of CHB converter, Figure 7. In this case 25 levels (for positive half period 10 ms is possible to count 13 levels). The results of harmonic analysis of this voltage is shown in Figure 8. There is wide band of side harmonic with the central frequency 6 kHz (12 x 500 Hz).

TABLE I. PARAMETERS OF SIMULATION MODEL

Title	Value
Rated power of symmetrization unit	$P_N = 12.5 \text{ MVA}$
AC catenary voltage	$u_r = 25 \text{ kV}_{RMS}$
L Filter	$L_{CHB12} = 3 \text{ mH}$ $L_{CHB23} = 3 \text{ mH}$ $L_{CHB31} = 3 \text{ mH}$
DC-link capacitors	$C = 10 \text{ mF}$
Rated DC-link voltage of capacitor	$U_C = 3050 \text{ V}$
Switching frequency of IGBTs	$f_{swit} = 250 \text{ Hz}$

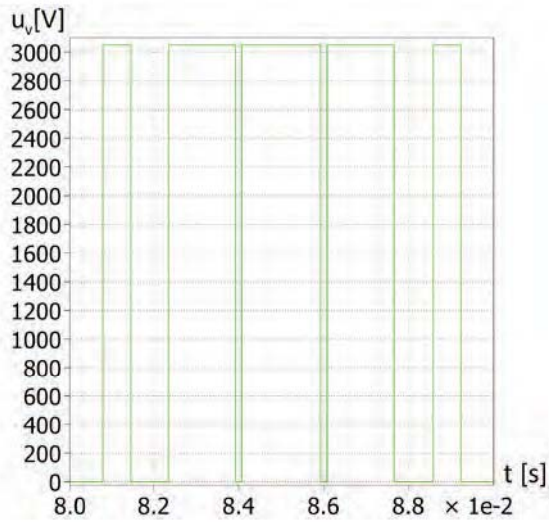

Figure 4. Voltage at AC terminals of single HB cell (250 Hz saw signal for single HB)

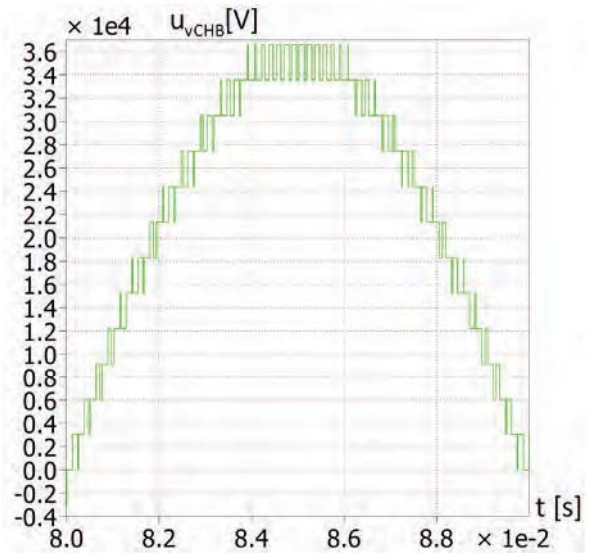

Figure 7. Voltage at AC terminals of 25-level CHB converter (under PS-PWM with zero vector alternating, half period of voltage 10 ms of 50 Hz signal)

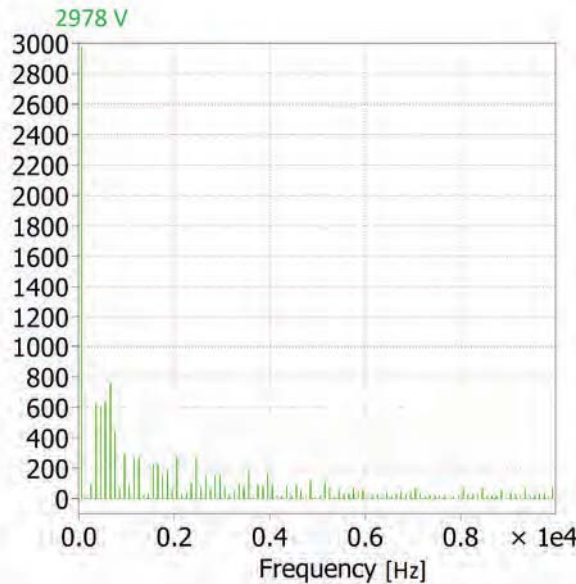

Figure 5. Harmonic analysis of voltage at AC terminals of single HB cell (250 Hz saw signal for single HB)

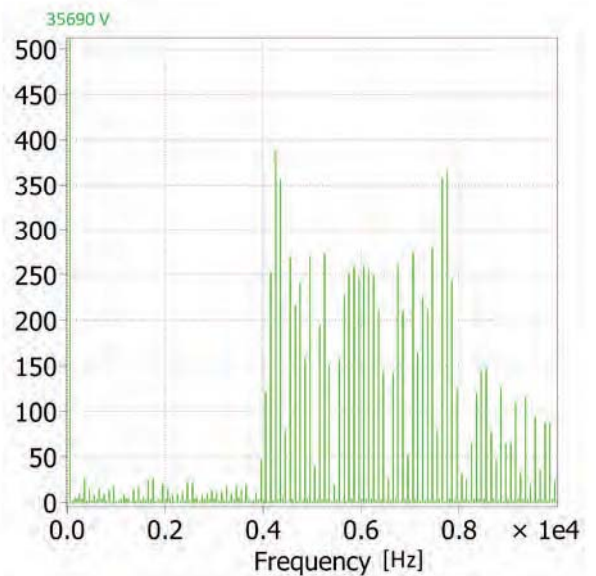

Figure 8. Harmonic analysis of Voltage at AC terminals of 25-level CHB converter

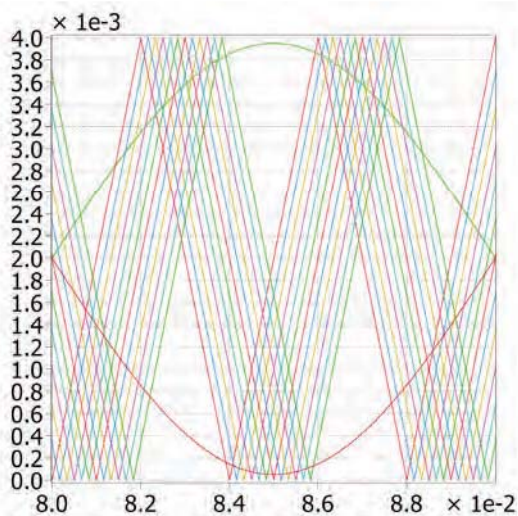

Figure 6. The PS-PWM signals of 25-level CHB multilevel converter (12 x saw signals 2 x control signals, modulation with zero vector alternating, half period 10 ms of 50 Hz)

The low ripple of AC current (i_{bal}) is the result of suitable harmonic composition of AC voltage (u_{vCHB}). The behavior of resulting branch current (i_{bal}) is shown in Figure 9. The harmonic analysis result is shown in Figure 10. The wide band around 6 kHz (from 4 kHz to 8 kHz) is the result again.

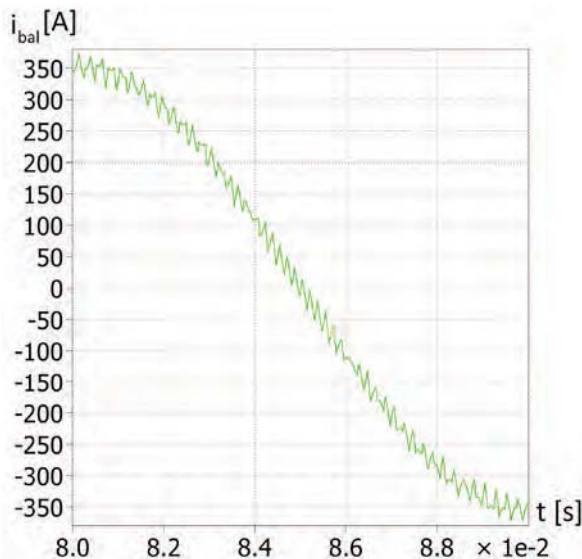

Figure 9. AC current of 25-level CHB converter (under PS-PWM with zero vector alternating, half period of voltage 10 ms of 50 Hz signal)

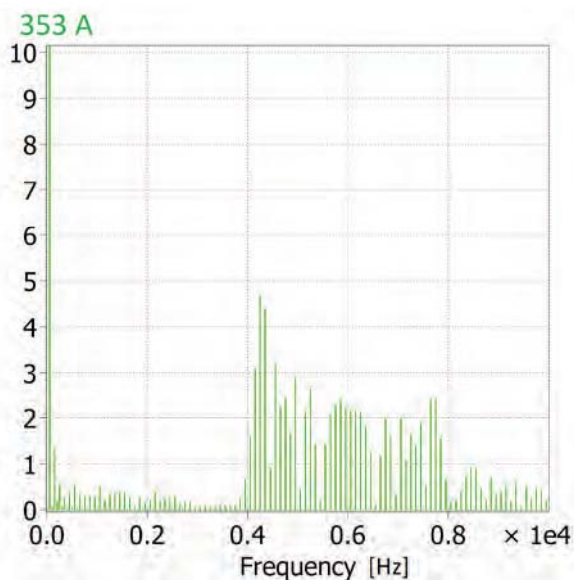

Figure 10. Harmonic analysis of AC current of 25-level CHB converter

III. CONCLUSION

This paper presents the results of CHB multilevel converter analysis. Where the PS-PWM is used as suitable modulation technique for a twelve-cell CHB converter. This paper is based on harmonic analysis of PWM HB cells with asymmetrical sampling used with triangular carrier based on zero voltage alternating modulation. The paper is closely linked with [9], where the results for single H-bridge cell are presented. These results are extended for full CHB converters used as an electronic balancer for traction substation. These results are based on created model of electronic balancer. The resulting harmonic spectrum is

appropriate to compare with common three-phase converter, this analysis can be found in [10] and [11]. The advantage of used modulation technique (PS-PWM) is the possibility of using low switching frequency (250 Hz) with resulting fine harmonic distribution, Figure 10.

ACKNOWLEDGMENT

This research has been supported by the Ministry of Education, Youth and Sports of the Czech Republic under the project OP VVV Electrical Engineering Technologies with High-Level of Embedded Intelligence CZ.02.1.01/0.0/0.0/18_069/0009855 and under project SGS-2018-009.

REFERENCES

- [1] L. G. Franquelo, J. Rodriguez, J. I. Leon, S. Kouro, R. Portillo, M. A. M. Prats, "The age of multilevel converters arrives", *IEEE Ind. Electron. Mag.*, vol. 2, no. 2, pp. 28-39, Jun. 2008.
- [2] S. Kouro et al., "Recent advances and industrial applications of multilevel converters", *IEEE Trans. Ind. Electron.*, vol. 57, no. 8, pp. 2553-2580, Aug. 2010.
- [3] R. Grünbaum, "SVC for the Channel Tunnel rail link: Providing flexibility and power quality in rail traction," *IEEE Seminar on Power - it's a Quality Thing*, London, 2005, pp. 1-2.
- [4] R. Gruber, D. O'Brien, "Use of Modular Multilevel Converter (MMC) Technology in Rail Electrification AusRAIL 2014, Perth Australia, May 2015.
- [5] C. Zhao, D. Dujic, A. Mester, J. K. Steinke, M. Weiss, S. Lewdeni-Schmid, T. Chaudhuri, and P. Stefanutti, "Power Electronic Traction Transformer Medium Voltage Prototype," *IEEE Transactions on Industrial Electronics*, vol. 61, no. 7, pp. 3257-3268, Jul. 2014.
- [6] Buticchi G., Barater D., Lorenzani E., Concarì C. and Franceschini G., "A Nine-Level Grid-Connected Converter Topology for Single-Phase Transformerless PV Systems," *IEEE Trans. Ind. Electron.*, on , vol.61, no.8, pp.3951-3960, Aug. 2014.
- [7] D. Grahame Holmes, Thomas A. Lipo, "Modulation of One Inverter Phase Leg," in *Pulse Width Modulation for Power Converters: Principles and Practice*, , IEEE, 2003.
- [8] V. Blahnik, T. Kosan, Z. Peroutka and J. Talla, "Control of a Single-Phase Cascaded H-Bridge Active Rectifier Under Unbalanced Load," in *IEEE Transactions on Power Electronics*, vol. 33, no. 6, pp. 5519-5527, June 2018.
- [9] V. Blahnik and J. Talla, "Analysis of single-phase voltage-source active rectifier under PWM," in *Mechatronics 2017 : Recent Technological and Scientific Advances (Advances in Intelligent Systems and Computing; Vol. 644)*. Cham: Springer, 2018, pp. 34-42.
- [10] V. Kus, T. Josefova and P. Bilik, "Harmonic currents generated by the voltage-source active rectifier," *4th International Conference on Power Engineering, Energy and Electrical Drives, Istanbul, 2013*, pp. 373-378.
- [11] V. Kus and T. Josefova, "Current harmonics of voltage-source active rectifier with random switching frequency," *Proceedings of the 2014 15th International Scientific Conference on Electric Power Engineering (EPE), Brno, 2014*, pp. 193-196.