

Novel Soft-Switching High Gain Transformerless DC-DC Converters without Auxiliary Switches for Renewable Energy Systems

Pravat Biswal¹, V.V.Subrahmanya Kumar Bhajana^{1,2}, Pavel Drabek²

¹School of Electronics Engineering, KIIT University, Bhubaneswar, India

²Regional Innovation Centre for Electrical Engineering, University of West Bohemia, Pilsen, Czech Republic
pravat.biswalfet@kiit.ac.in, kumarbvv@rice.zcu.cz, bvvs.kumarfet@kiit.ac.in, drabek@ieee.org

Abstract – This paper presents new soft-switching transformerless DC-DC converters without auxiliary switches. The soft-switching operation is achieved with the aid of simple resonant cell, which comprises of an inductor, a capacitor and a diode. In addition to the auxiliary cell, a voltage multiplier cell also included in order to ensure high voltage conversion ratio. The major advantages of the proposed converters are reduced turn on/turn off losses, high conversion ratio and very simple auxiliary circuitry. A resonant cell is incorporated in this converter which is used to turn on the main switching devices at zero current and turn them off at zero current. The zero current switching operation is achieved with a simple auxiliary cell. This paper describes the operation principles and the design simulations of proposed converters. The theoretical analysis of the proposed converters is validated by the simulation analysis on 12V/360V/1kW converter systems.

Keywords–component; formatting; style; styling; insert (key words)

I. INTRODUCTION

Transformerless DC-DC converters are plays a significant role to improve the voltage conversion ratios in applications such as battery energy storage systems (BESS) and renewable energy conversion systems (fuel cell, solar cell and photovoltaic cells). However, due to inherent low voltage characteristics of the renewable energy sources, a high gain, high efficient DC-DC converter is necessary for industry demands. In the initial days of research, DC-DC converter [1] without a transformer is introduced on buck converter in addition to the voltage dividers which are capable to operate under small duty ratios and high switching frequencies. On the other hand a transformerless step-up converter [2] with switched capacitor circuits has been introduced to obtain required voltage conversion ratios. Without using large duty ratios on the main switches, another high step-up converter [3] has been developed with dual voltage lift cells. However, this converter achieved high voltage conversion ratio at low output power

level. In addition to reducing the volume and cost, other literature is focused on reduced voltage and current stresses in their switching devices that are mitigated through hybrid converters [4], which are realized with different combinations of switched capacitor/switched inductor structures. Instead of input inductors, the switched inductors were utilized to increase the voltage gain. However, the usage of switched inductors [5] resulted in increased volume and cost of the overall configuration. Furthermore, voltage stresses of switches and diodes are reduced by a voltage quadrupler in high step-up converters [6]. In other literature, to increase gain factor >10, two multiplier cells are introduced [7] in a transformerless converter (TLC). Then, in order to reduce the extreme duty ratios to the main switches in TLC, an extra switch and diodes are used [8-9]. To achieve better efficiency in TLCs, the soft-switching operation of the main switches is the alternate solution. The zero current switching (ZCS) operation is achieved in a TLC with the help of additional auxiliary circuit [10].

The main aim of this paper is to achieve soft-switching operation without using auxiliary switches and to obtain gain factor in TLCs, which is more than 20. The previously existed converters [3] [9] [10] are operated at low power with a gain factor just over 10. The proposed topologies in this paper are targeted to operate at high power levels and achieve gain factor well over 20. This paper proposes soft-switching TLCs with simple auxiliary cells and a multiplier at the output side. The auxiliary cell can provide soft-switching operations to all switching devices and multiplier cell impose an increased gain factor. The proposed converter system can be applicable for high power applications. This paper presented two topologies, first one with 12V/214V/450 W system and second topology with 12V/360V/1.3 kW. The proposed converter description and its operation principles are discussed in section II and section III presents simulation evaluations of proposed converters.

II. PROPOSED TRANSFORMERLESS CONVERTERS DESCRIPTION AND ITS OPERATION PRINCIPLES

The proposed converter topologies are illustrated in Fig.1 and Fig.2. Fig.1 is derived from conventional transformerless converters [3] and Topology II is the

This research has been supported by the Ministry of Education, Youth and Sports of the Czech Republic under the project OP VVV Electrical Engineering Technologies with High-Level of Embedded Intelligence CZ.02.1.01/0.0/0.0/18_069/0009855 and project No. SGS-2018-009

extended version of [8] shown in Fig.2. Both the topologies are introduced with an additional auxiliary cell and a multiplier at output side. Topology I consists of the main IGBTs S_1 , S_2 and input inductors L_1 , L_2 . The auxiliary cell comprises of three elements such as an inductor L_m , a diode D_m and a capacitor C_m . The voltage multiplier consists two diodes D_p , D_q and two capacitors C_p , C_q .

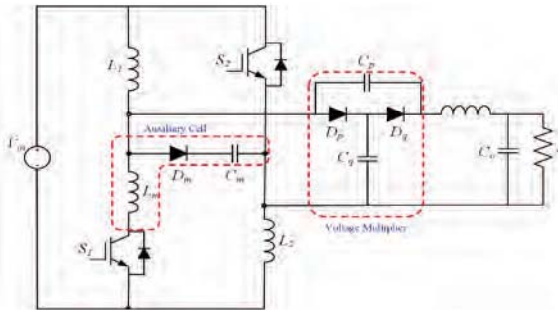

Figure 1. Proposed transformerless converter topology-I

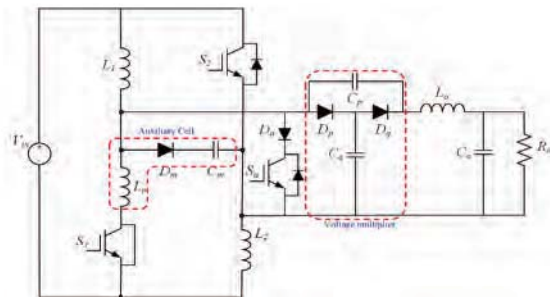

Figure 2. Proposed transformerless converter topology-II

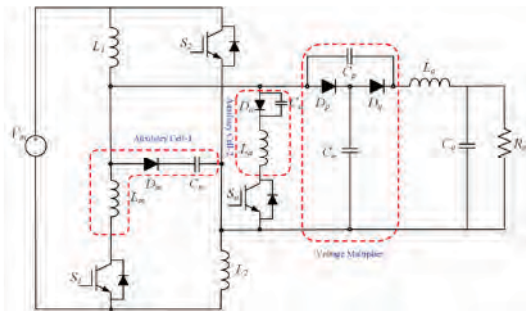

Figure 3. Proposed transformerless converter topology-III

The auxiliary cell used in these topologies mitigates soft-switching operation and multiplier cell provides high conversion ratio as compared with existing versions [3] [7-9]. Topology II comprises of three switches S_1 , S_2 and S_a . To obtain soft-switching to S_1 , S_2 an additional auxiliary cell is assisted with an inductor L_m , a diode D_m and a capacitor C_m . The IGBT S_a is also self-assisted with an additional resonant elements L_a , C_a and a diode, D_a as shown in Fig.3. The topology-I can have gain <20 and topology-II and topology-III, exhibits gain more than 20. The operation of topology-I is divided in to four intervals t_0 - t_4 , which is shown in Fig.4. The operation of topology-III is explained with the help of key waveform shown in Fig.5. Topology II operation similar to Topology-III except the soft-switching

operation of S_a . For simplicity, the topology-II operation is not exhibited.

A. Topology -I

The operation of the proposed topology is divided into four intervals from t_0 - t_4 . At t_0 , the switches S_1 , S_2 are turned on. The inductor, L_a current increases linearly and C_a is discharged to the level of half of the output voltage. The output power is delivered by the previously energy stored in charged C_p and C_o .

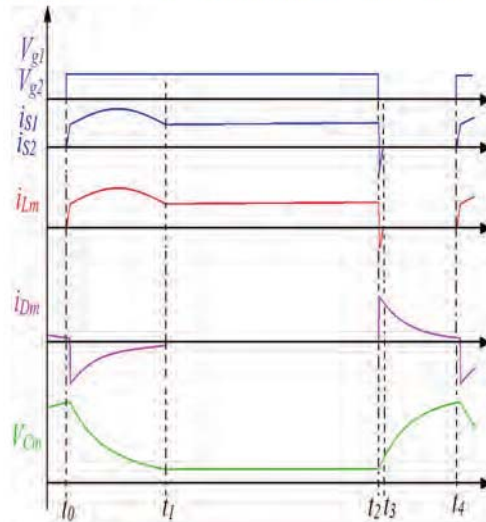

Figure 4. Key waveform : Topology-I

During the interval t_1 - t_2 , the energy will be accumulating by L_1 , L_2 . The interval, t_2 - t_3 , is a short resonant time interval in which the current through the S_1 , S_2 falls to zero, therefore the ZCS condition is achieved for both the IGBTs S_1 , S_2 . The capacitor C_a charges to the level of output voltage and direction of L_a current changes, which linearly decreases to zero at t_4 . The body diodes of S_1 , S_2 conducts to create a path for resonant current until t_3 . During the interval t_3 - t_4 , the S_1 , S_2 are turned off and the load is fed by the previously accumulated energy by L_1 , L_2 .

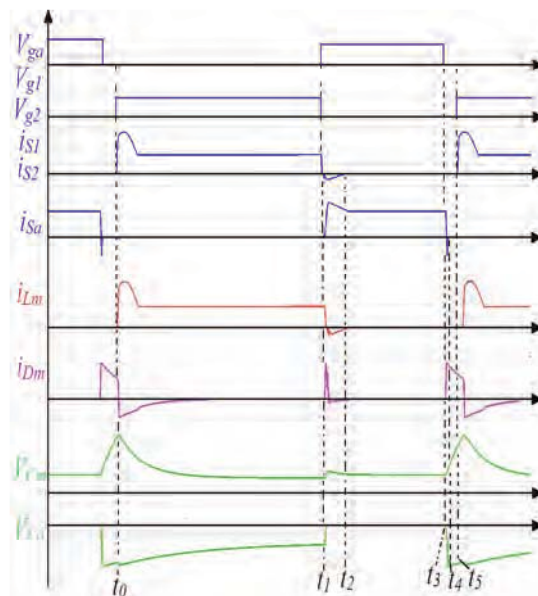

Figure 5. Key waveform : Topology-III

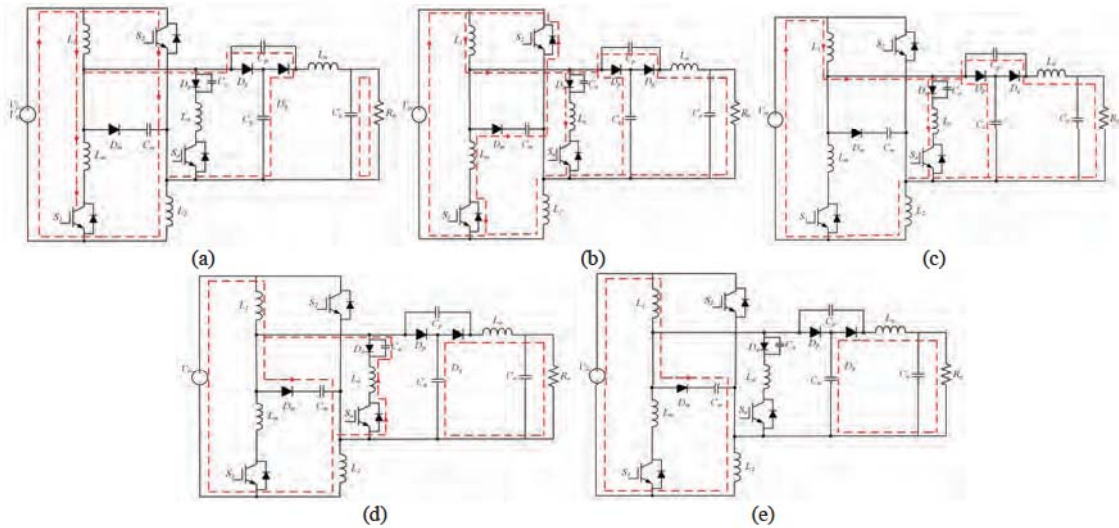

Figure 6. Equivalent current flow schematics (a) interval (t_0-t_1) (b) interval (t_1-t_2) (c) Interval (t_2-t_3) (d) Interval (t_3-t_4) (e) Interval (t_4-t_5): Topology-III

B. Topology -III

The operation of topology-III is divided into five intervals, t_0-t_5 . Its equivalent current flow schematics are shown in Fig.6. At t_0 S_1 , S_2 are turned on. Throughout this interval, energy is accumulated by L_1 , L_2 . The capacitor C_a is discharged from the level $2V_o$ and inductor L_a is at $-L_m$. At time t_1 , the IGBT S_a is turned on and S_1 , S_2 are turned off, since the currents reached zero. Then the body diodes of S_1 , S_2 start conducting. Thus, the ZCS condition is achieved for S_1 , S_2 . At the beginning of this interval t_1-t_2 , the L_a , C_a are resonating each other and diode D_m conducted for a short duration. Then i_{La} , V_{Ca} are maintained at constant and diode D_m stops conducting. During the interval t_2-t_3 , the IGBT, S_a will be conducting. At t_3 , the IGBT, S_a current decreases to zero and then body diode conducts till t_4 . Therefore, the ZCS turn off condition achieved. From t_4-t_5 , all switches are in turned off, since there

III. SIMULATION EVALUATIONS

The designs are simulated on MATLAB simulink for the proposed topologies. The simulation parameters used for the Topology I are as follows: $V_m = 12$ V ; switching frequency $f_s = 50$ kHz; output voltage $V_o = 214$ V ; output power = 450 W; $L_m = 1$ μ H ; $C_m = 3$ nF ; $L_1, L_2 = 100$ μ H ; $C_o = 100$ μ F. Fig.7 shows the obtained simulated voltage and current waveforms of S_1 , S_2 . It is observed from the obtained results, the IGBTs S_1, S_2 are turned off with zero current switching (ZCS). Thus, the voltage and current stresses are significantly reduced. Fig.8 shows the voltage and current waveforms of C_m , L_m , D_m , D_p and D_q . The peak voltage across C_m is V_o , current through the D_m is 0.2A and currents through D_p , D_q are nearby half of the input current. The overall gain of the proposed topology I is exactly 18 as compare with the existing versions have < 10 [3] [7-9]. However, the existed topologies [8] [9] are operated under 200 W output power, whereas the proposed topology is operated 450W without increasing additional switching losses.

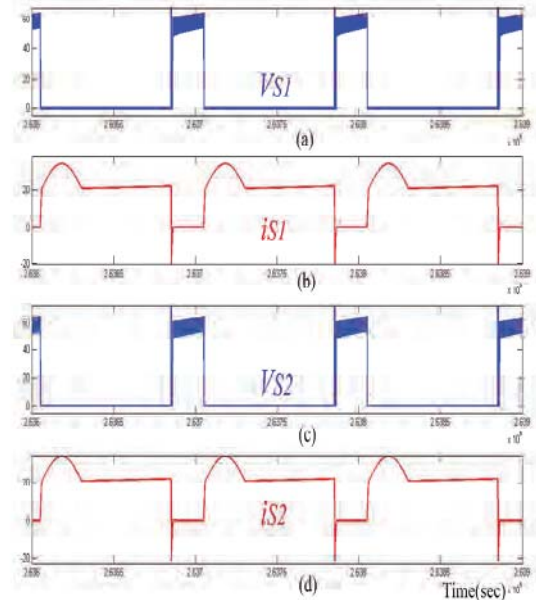

Figure 7 Simulated waveforms (a) V_{S1} (b) i_{S1} (c) V_{S2} (d) i_{S2}

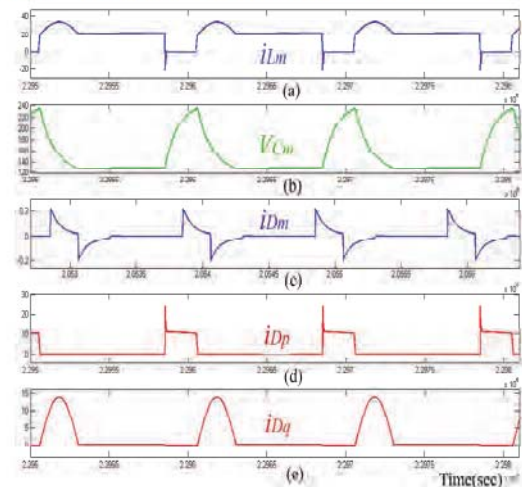

Figure 8 Simulated waveforms (a) i_{Lm} (b) V_{Cm} (c) i_{Dm} (d) i_{Dp} (e) i_{Dq}

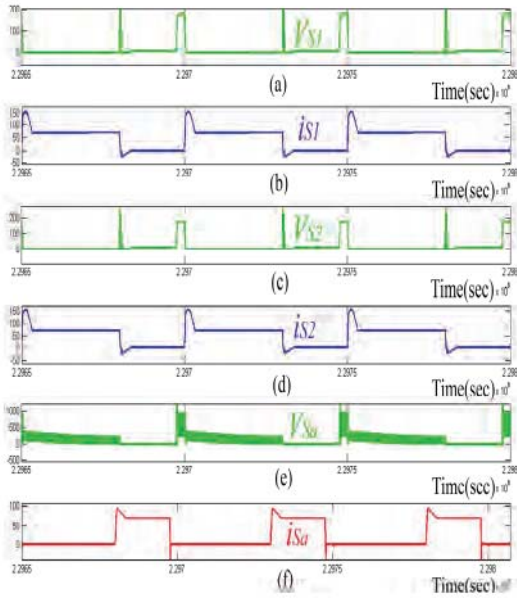

Figure.9 Simulated waveforms (a) V_{S1} (b) i_{S1} (c) V_{S2} (d) i_{S2} (e) V_{Sa} (f) i_{Sa} : Topology-III

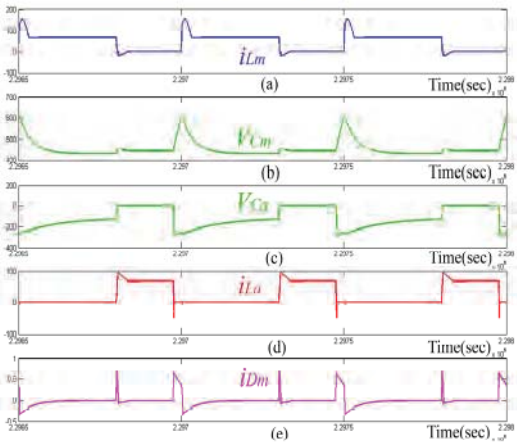

Figure.10 Simulated waveforms (a) i_{Lm} (b) V_{Cm} (c) V_{Ca} (d) i_{La} (e) i_{Dm} : Topology-III

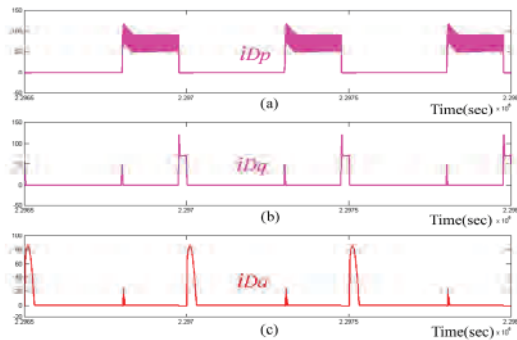

Figure.11 Simulated waveforms (a) i_{Dp} (b) i_{Dq} (c) i_{Da}

In similar way, the simulations are performed for proposed topology III. The parameters used in the design is as follows: $V_m=12V$; $V_o=360V$; $P_o=1.3kW$; $f_s=50kHz$; $L_m=0.1\mu H$; $C_m=3nF$; $L_a=0.5\mu H$; $C_a=10nF$. Fig.9 shows the voltage and current waveforms of S_1 , S_2 and S_a . It can be seen that, the ZCS turn off condition is achieved for all the switches. Fig.10 shows the voltage and current waveforms of C_m , C_a , L_m , L_a and D_m . Fig.11 shows the current waveforms of diodes D_p , D_q and D_a . The overall gain obtained for topology is >25 as compare with existing converters

[3] [7-9], as the gain factors of existing versions are below 20 and output power is below 500 W. The proposed topology can be operated at 1.3 kW with the aid of multiplier cell and soft-switching, obtained by a simple auxiliary cell.

IV. CONCLUSION

This paper proposes soft-switching transformerless converters for renewable energy conversion systems. The simulations analysis performed on two topologies, the first topology with 12V-214V system operated at 450W output power and second topology with 12V-360V-1.3kW system. The proposed topologies are incorporate with an additional simple auxiliary cell and a multiplier at the output side. Auxiliary cell provides soft-switching characteristics to the IGBTs and multiplier cell enhances the conversion ratios wellover the existing topologies. The gain factor of the proposed topologies I is just below 20 and for the other, it is above 20. The proposed soft-switching transformerless converters will be the alternate solution for increased conversion ratios and high output powers with higher efficiencies.

REFERENCES

- [1] R. D. Middlebrook, "Transformerless DC-to-DC Converters with Large Conversion Ratios," INTELEC '84 - International Telecommunications Energy Conference, New Orleans, LA, USA, 1984, pp. 455-460.
- [2] B. Axelrod, Y. Berkovich and A. Ioinovici, "Transformerless DC-DC converters with a very high DC line-to-load voltage ratio," Proceedings of the 2003 International Symposium on Circuits and Systems, 2003. ISCAS '03., Bangkok, 2003, pp. III-III.
- [3] L. Yang, T. Liang and J. Chen, "Transformerless DC-DC Converters With High Step-Up Voltage Gain," IEEE Transactions on Industrial Electronics, vol. 56, no. 8, pp. 3144-3152, Aug. 2009.
- [4] B. Axelrod, Y. Berkovich and A. Ioinovici, "Switched-Capacitor/Switched-Inductor Structures for Getting Transformerless Hybrid DC-DC PWM Converters," IEEE Transactions on Circuits and Systems I: Regular Papers, vol. 55, no. 2, pp. 687-696, March 2008.
- [5] L. Liu and S. Zhang, "Transformerless DC-DC PWM converters," 2015 IEEE 10th Conference on Industrial Electronics and Applications (ICIEA), Auckland, 2015, pp. 1386-1390.
- [6] C. Pan, C. Chuang and C. Chu, "A Novel Transformer-less Adaptable Voltage Quadrupler DC Converter with Low Switch Voltage Stress," IEEE Transactions on Power Electronics, vol. 29, no. 9, pp. 4787-4796, Sept. 2014.
- [7] M. A. Salvador, T. B. Lazzarin and R. F. Coelho, "High Step-Up DC-DC Converter With Active Switched-Inductor and Passive Switched-Capacitor Networks," IEEE Transactions on Industrial Electronics, vol. 65, no. 7, pp. 5644-5654, July 2018.
- [8] M. Lakshmi and S. Hemamalini, "Nonisolated High Gain DC-DC Converter for DC Microgrids," IEEE Transactions on Industrial Electronics, vol. 65, no. 2, pp. 1205-1212, Feb. 2018.
- [9] M. Sagar Bhaskar, M. Meraj, A. Iqbal, S. Padmanaban, P. Kiran Maroti and R. Alammar, "High Gain Transformer-Less Double-Duty-Triple-Mode DC/DC Converter for DC Microgrid," IEEE Access, vol. 7, pp. 36353-36370, 2019.
- [10] V. V. S. K. Bhajana and P. Drabek, "Novel ZCS Transformerless High Gain DC-DC Converters for Renewable Energy Conversion Systems," IEEE 28th International Symposium on Industrial Electronics (ISIE), Vancouver, BC, Canada, pp. 2533-2538, 2019.