

PRAVÝ BOKORYSNÝ POHLED

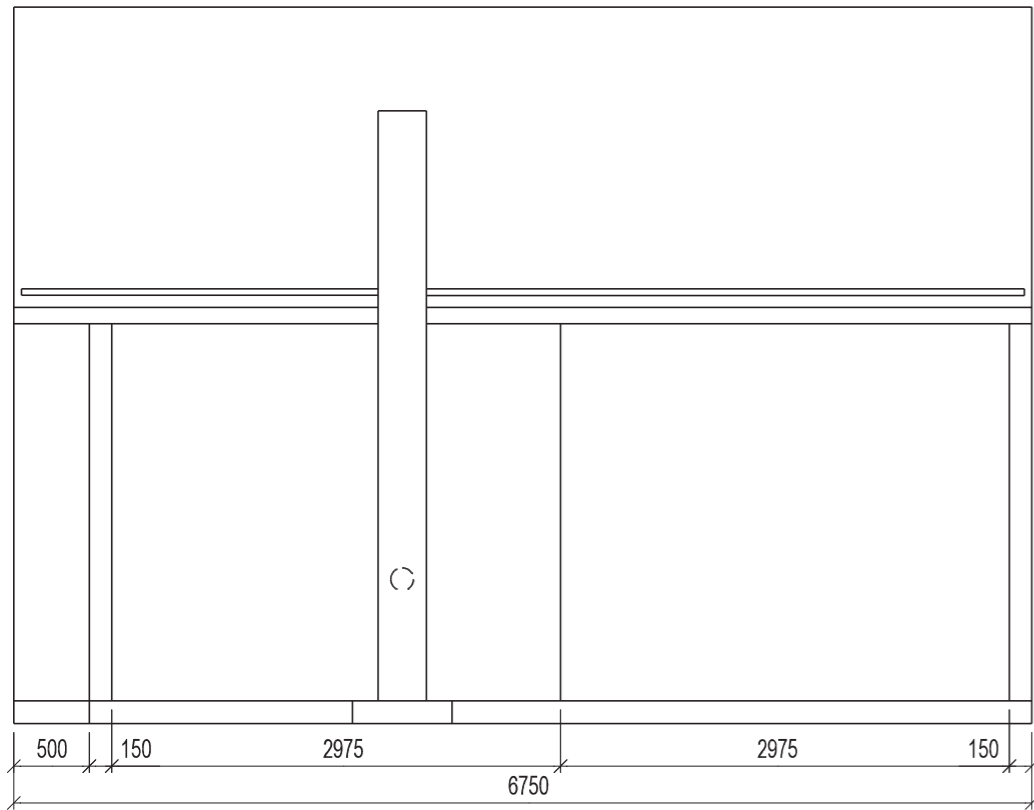

ČELNÍ POHLED

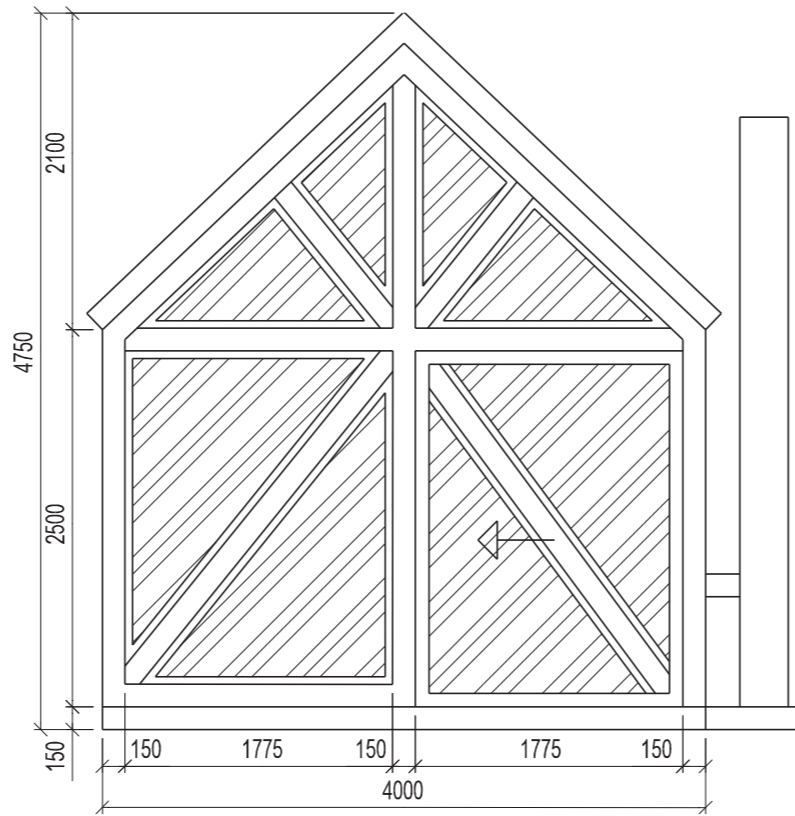

LEVÝ BOKORYSNÝ POHLED

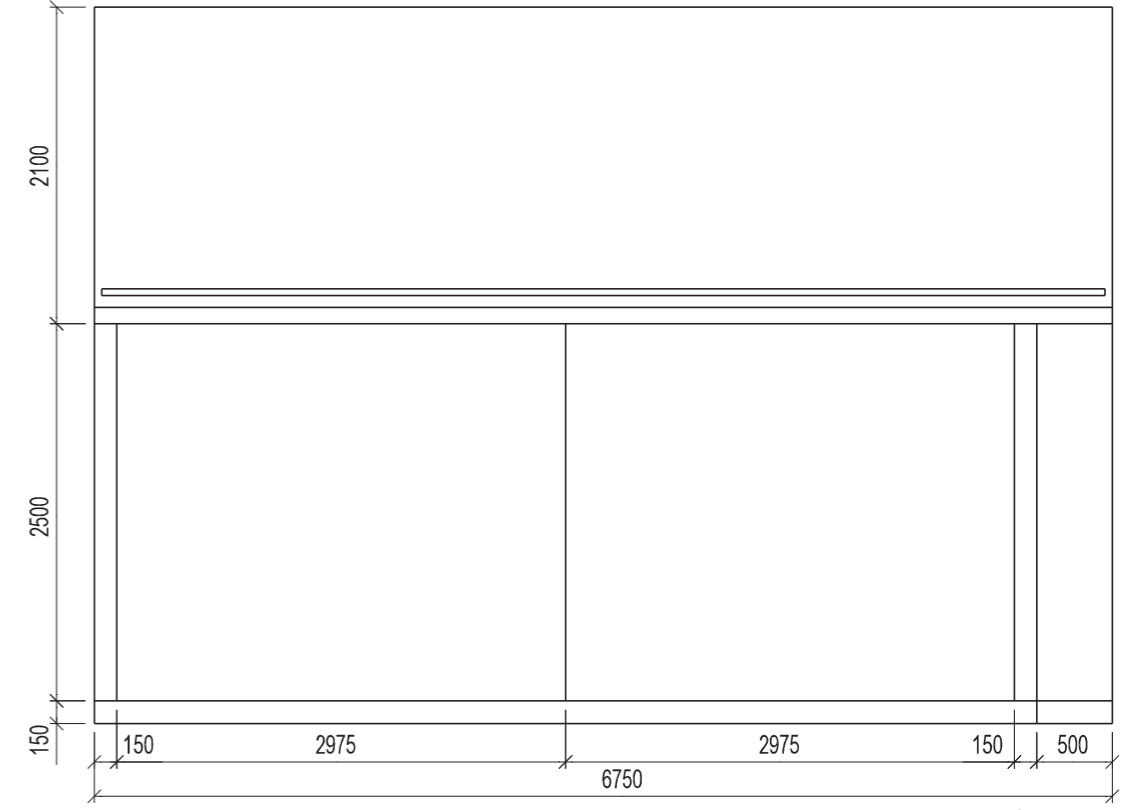

ZADNÍ POHLED

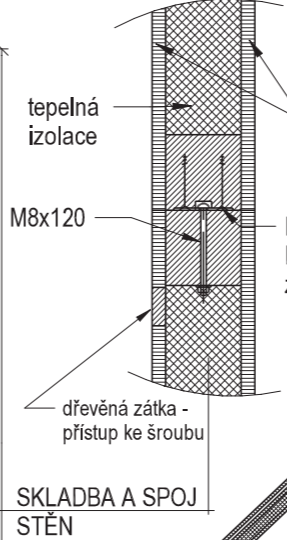
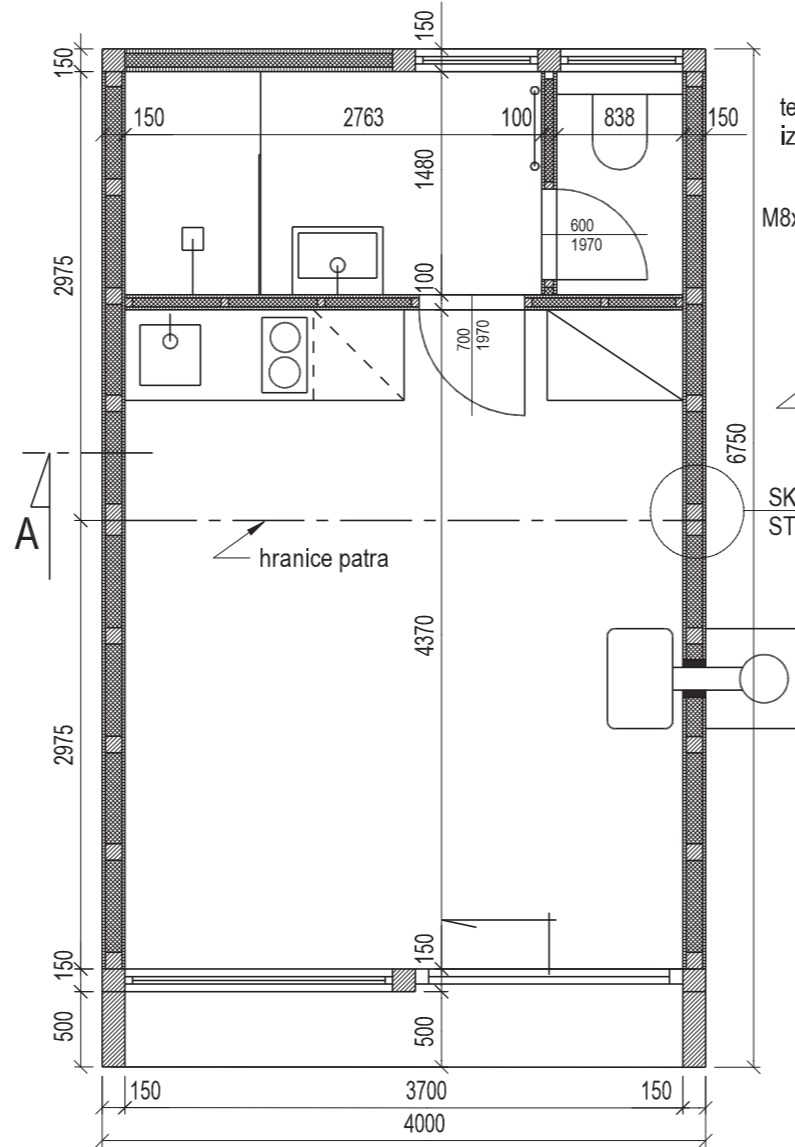
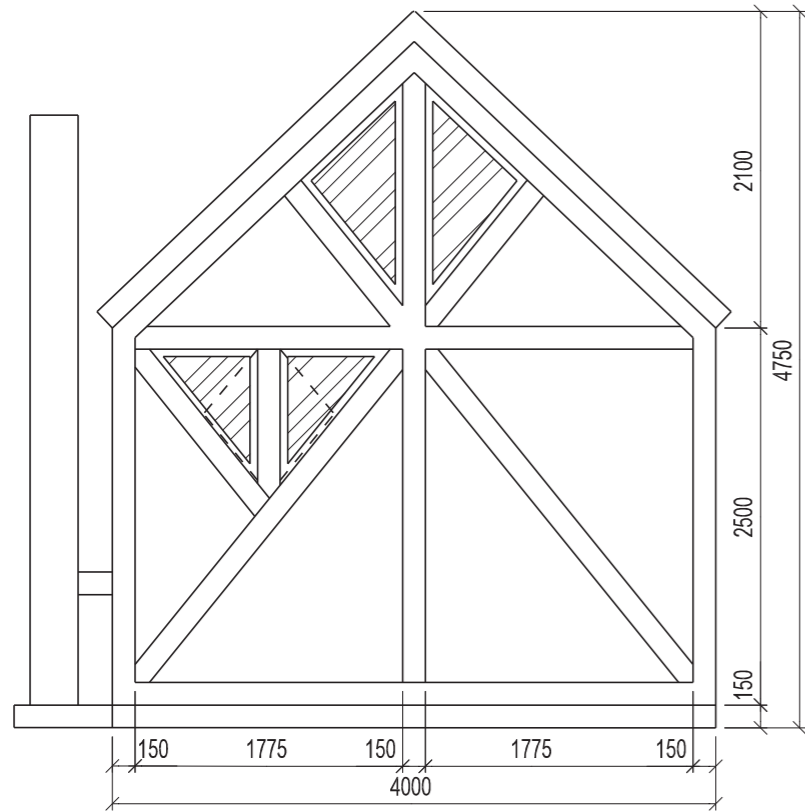

ŘEZ A - A

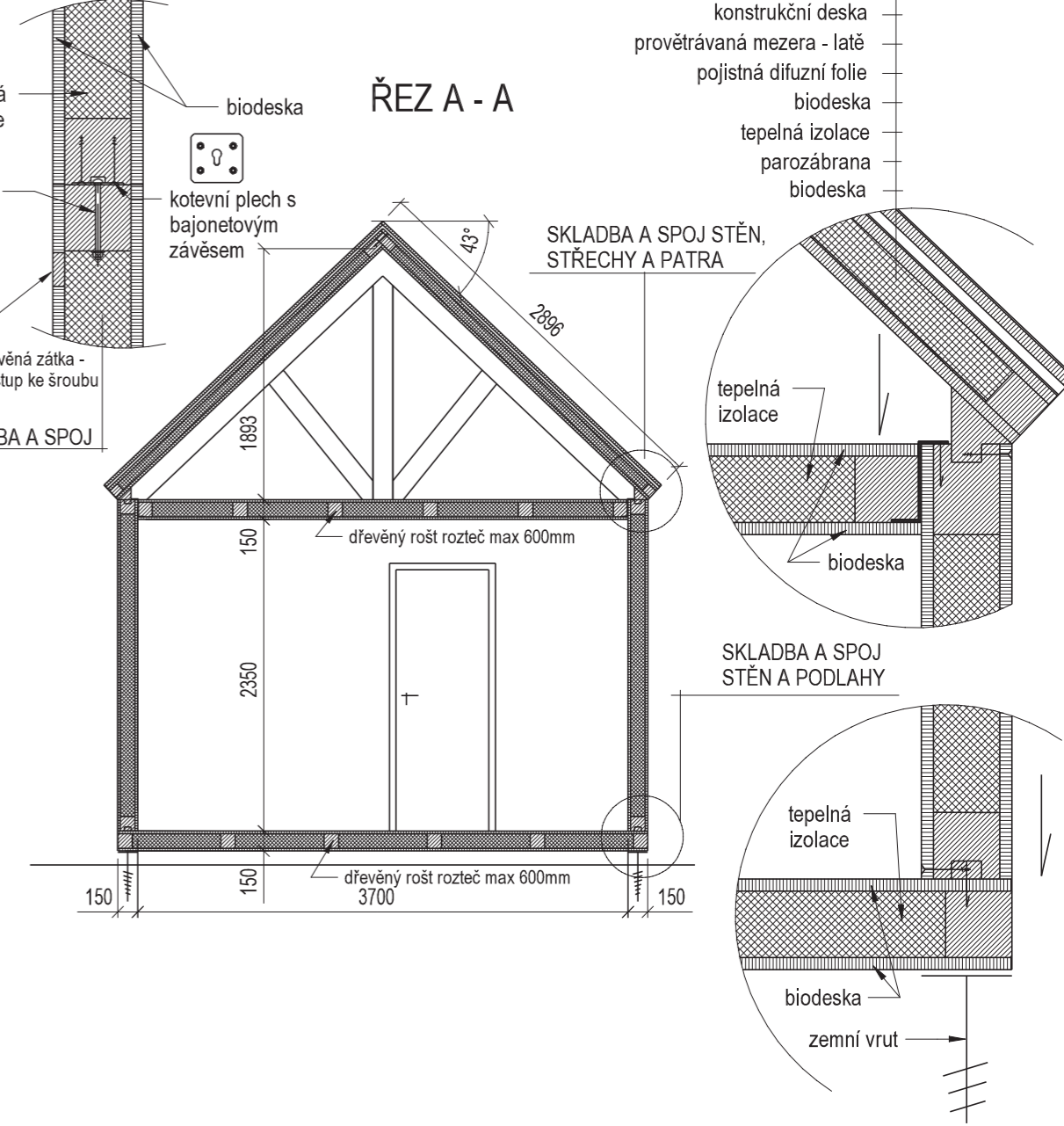

- plechová krytina
- konstrukční deska
- provětrávaná mezera - latě
- pojistná difúzní folie
- biodeska
- tepelná izolace
- parozábrana
- biodeska

SKLADBA A SPOJ STĚN, STŘECHY A PATRA

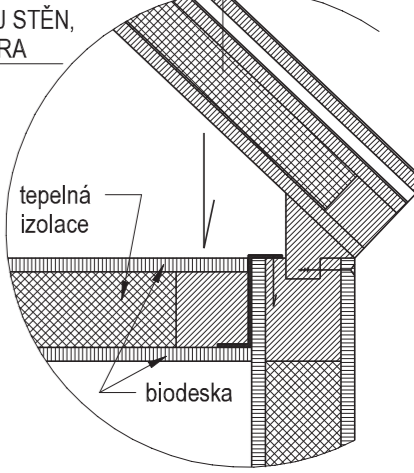

SKLADBA A SPOJ STĚN A PODLAHY

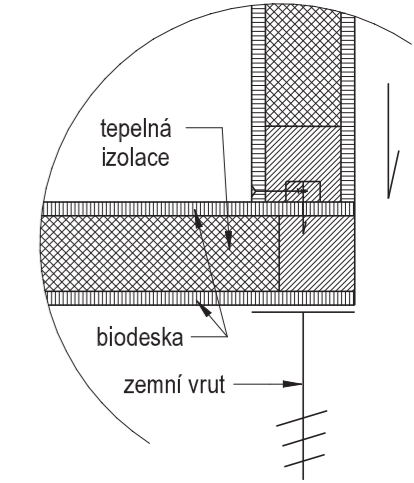

TECHNICKÝ VÝKRES
 VÍKENDOVÁ CHATA LÉVA
 Varianta A
 BcA. Martina Jandová

formát A3
 M1:50